

# Polly



# Polly

## UPHOLSTERY



fabric

## COMFORTS



standard



lux



classic

## COVERS



fixed



loose  
with velcro

## SPECIAL



modular  
system

Drawings shown height with leg no. 141A H-14.

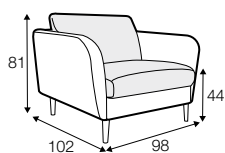

armchair

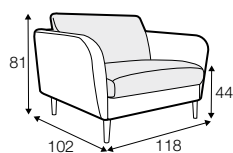

armchair wide

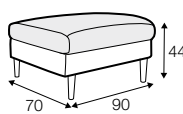

footstool 90x70

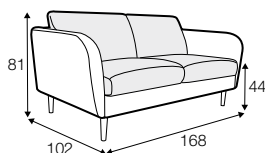

2 seater

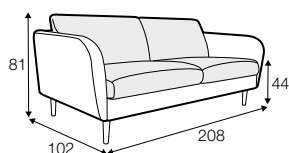

3 seater

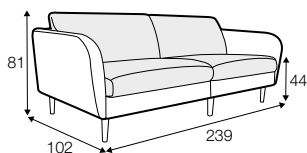

3XL seater (divided, two cushions)

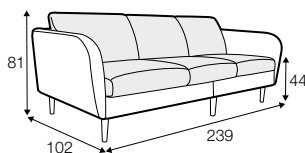

3XL seater (divided, three cushions)

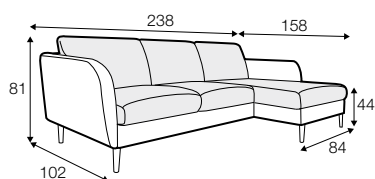

set 1 right / or left

2 seater left / or right  
+ chaiselongue right / or left

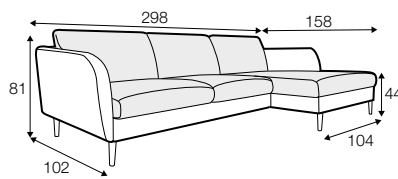

set 2 right / or left

3 seater left / or right  
+ chaiselongue wide right / or left

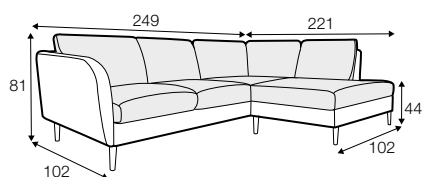

set 3 right / or left

2 seater left / or right + divan right / or left

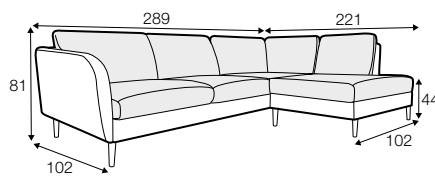

set 4 right / or left

3 seater left / or right + divan right / or left

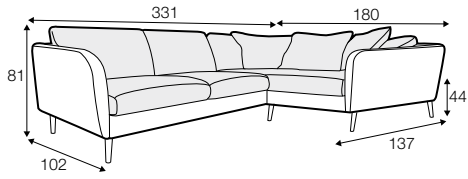

**set 5 right / or left**  
3 seater left / or right + cozy corner right / or left

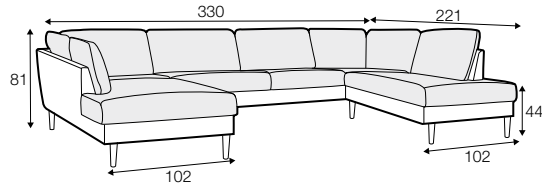

**set 6**  
divan left + 2 seater without armrests + divan right

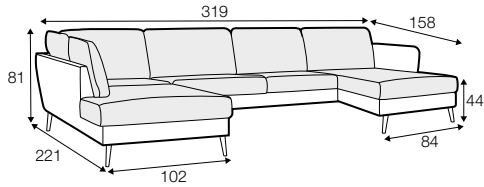

**set 7 left / or right**  
divan left / or right + 2 seater without armrests  
+ chaiselongue right / or left

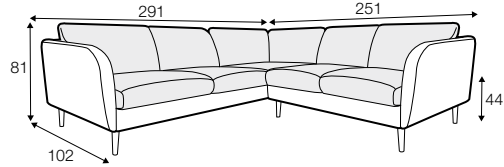

**set 8 right / or left**  
3 seater left / or right + corner 90° no. 1  
+ 2 seater right / or left

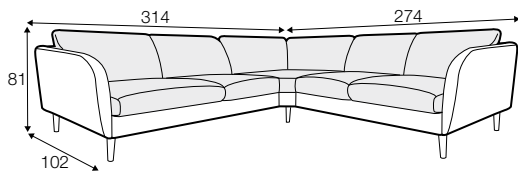

**set 9 right / or left**  
3 seater left / or right + corner 90° no. 2  
+ 2 seater right / or left

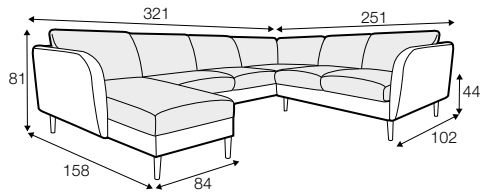

**set 10 left / or right**  
chaiselongue left / or right + 2 seater without armrests  
+ corner 90° no. 1 + 2 seater right / or left

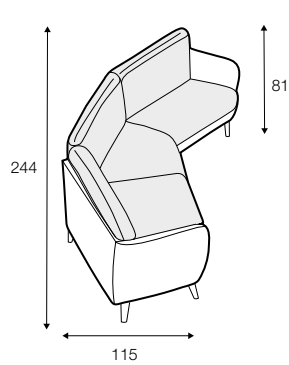

**set 13**  
armchair left + corner 30°  
+ armchair right

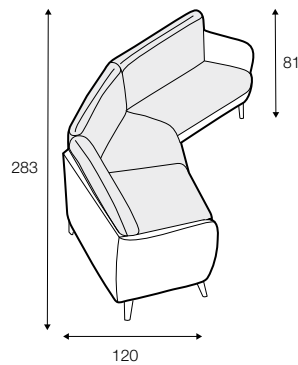

**set 14**  
armchair wide left + corner 30°  
+ armchair wide right

## modular system

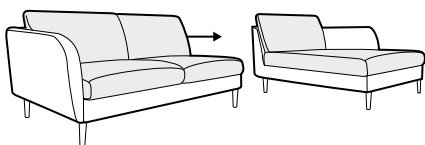

## elements of the modular system

---

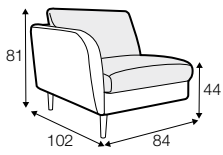

armchair left / or right

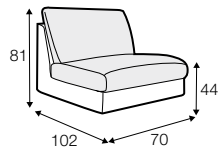

armchair without armrests

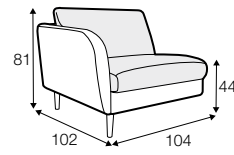

armchair wide left / or right

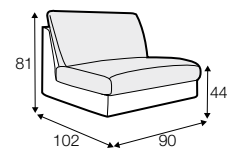

armchair wide without armrests

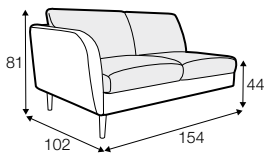

2 seater left / or right

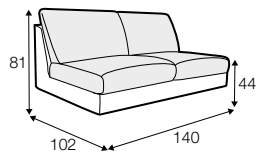

2 seater without armrests

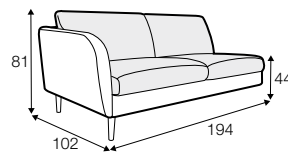

3 seater left / or right

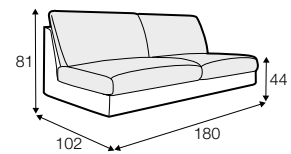

3 seater without armrests

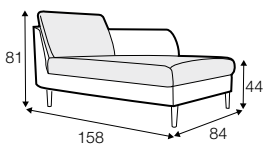

chaiselongue right / or left

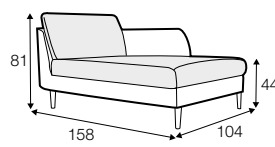

chaiselongue wide right / or left

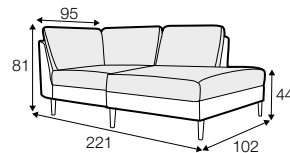

divan right / or left

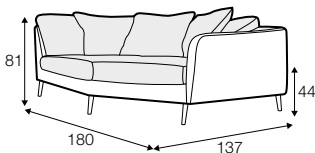

cozy corner right / or left

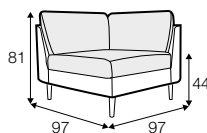

corner 90° no. 1

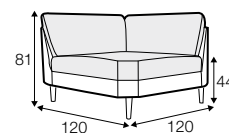

corner 90° no. 2

## accessories

---

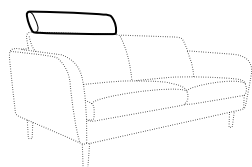

neckrest L-77

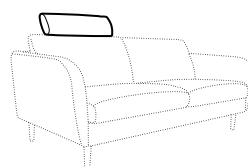
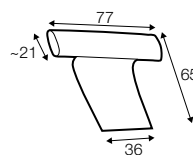

neckrest L-62

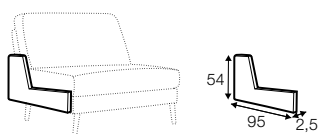
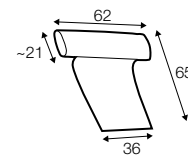

endpart left / or right

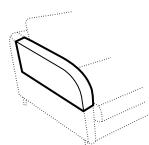

armrest protection

## extra dimensions

---

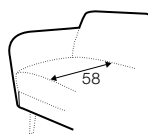

depth of seat

## legs

---

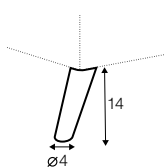

no. 141A  
wood  
recommended

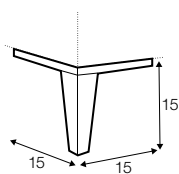

no. 152  
wood

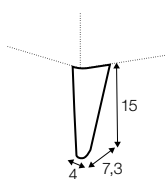

no. 91  
wood

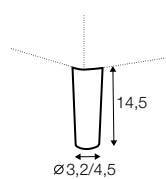

no. 153  
wood

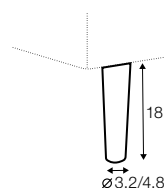

no. 141B  
wood

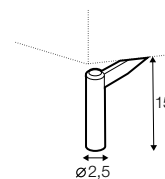

no. 145A  
metal chrome,  
painted black or grey  
and brushed steel\*

\*please check a cost of brushed steel finish with a sale representative.

## profile

---

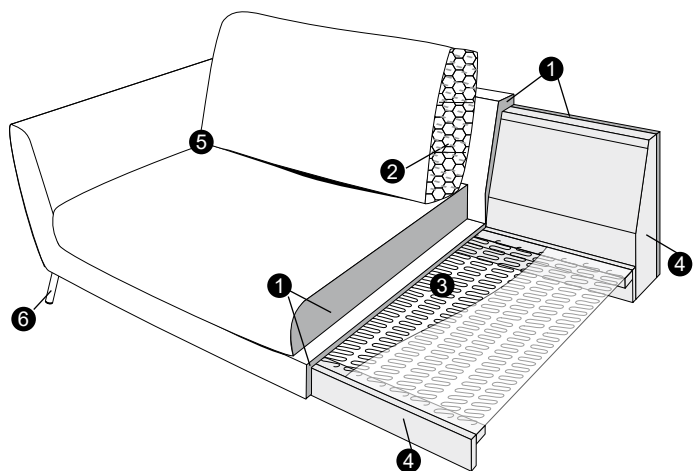

### classic

1. polyurethane foam/ high resilient polyurethane foam
2. foam flakes with silicone balls
3. springs
4. FSC® certified solid wood and wood based elements
5. fabric
6. FSC® certified solid wood or metal legs

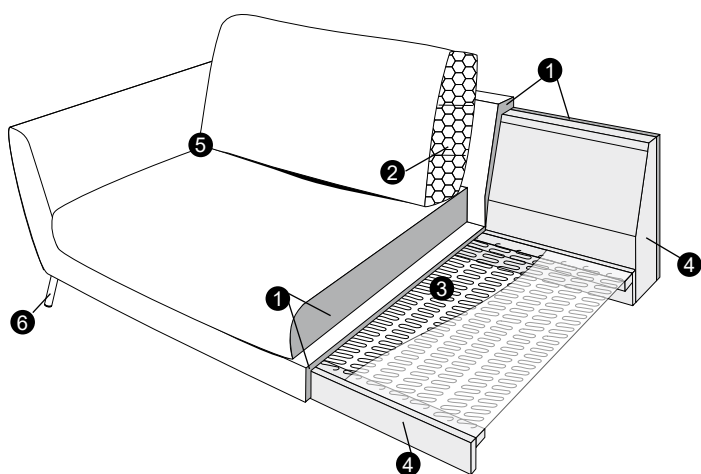

### standard

1. polyurethane foam/ high resilient polyurethane foam
2. silicone balls
3. springs
4. FSC® certified solid wood and wood based elements
5. fabric
6. FSC® certified solid wood or metal legs

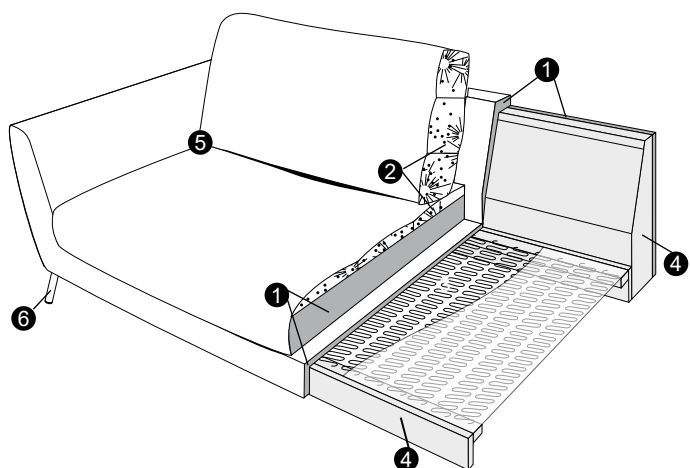

### lux

1. polyurethane foam/ high resilient polyurethane foam
2. cushion chamber with mix of feather and silicone balls
3. springs
4. FSC® certified solid wood and wood based elements
5. fabric
6. FSC® certified solid wood or metal legs