

# Impulse



# Impulse

## UPHOLSTERY



fabric



\*\*  
leather  
only in FC

## COMFORTS



STD standard



CLS classic



PLUS plus

## COVERS



FC fixed

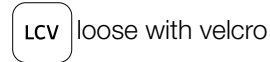

LCV loose with velcro



LC loose

## SPECIAL



modular  
system

Drawing show combinations with armrest I. Combinantons with other armrest are properly longer or shorter in width.

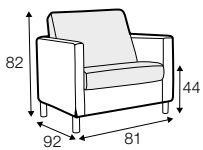

armchair

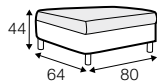

footstool 80x64

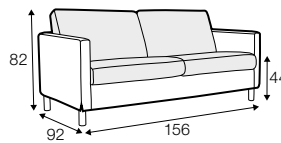

2 seater

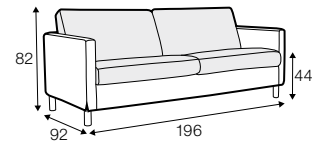

2,5 seater

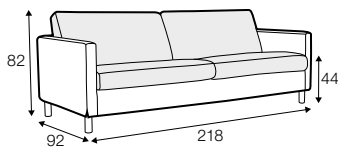

3 seater

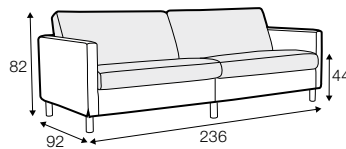

4 seater divided

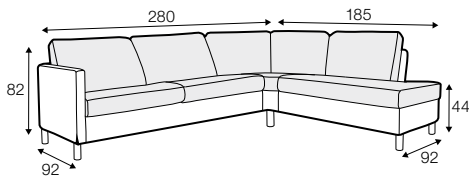

set 4 right / or left  
2,5 seater left / or right + divan right / or left

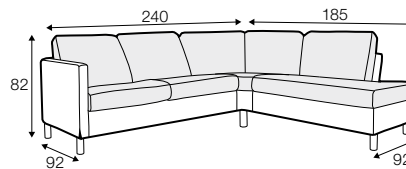

set 5 right / or left  
2 seater left / or right + divan right / or left

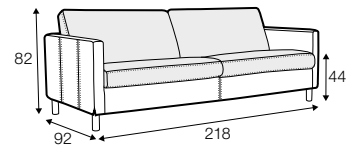

example of leather cover  
3 seater

## modular system

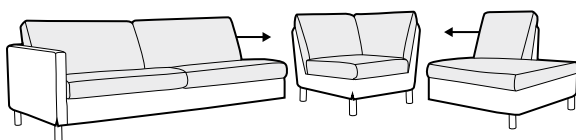

## elements of the modular system

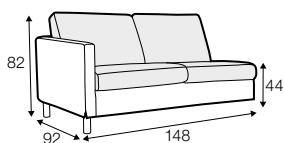

2 seater left / or right

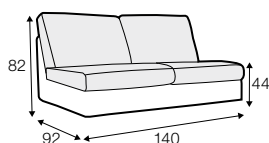

2 seater  
without armrests

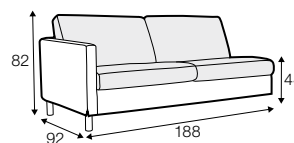

2,5 seater left / or right

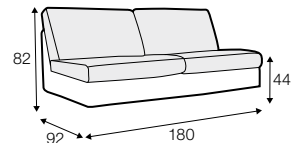

2,5 seater  
without armrests

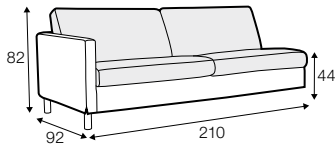

3 seater left / or right

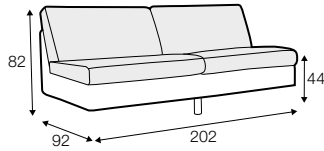

3 seater  
without armrests

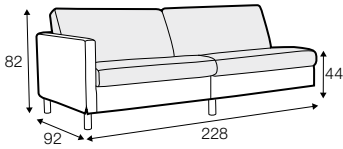

4 seater divided left / or right

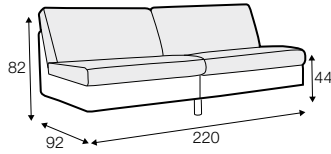

4 seater divided  
without armrests

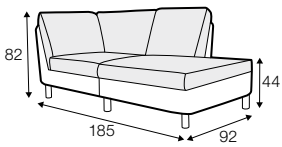

divan right / or left

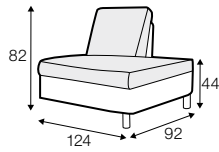

bench right / or left

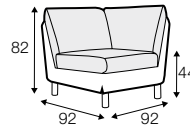

corner 90°

## extra dimensions

---

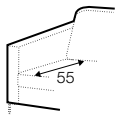

depth of seat

## accessories

---

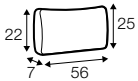

cushion

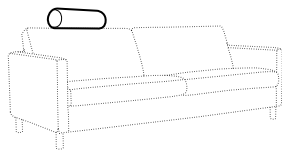

headrest with roll L-60

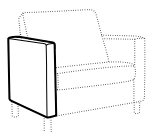
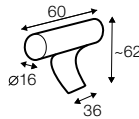

armrest I

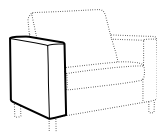
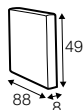

armrest II

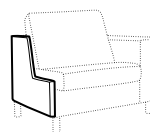
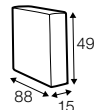

endpart left / or right



## legs

---

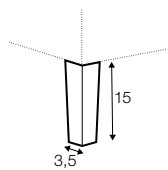

no. 109  
wood

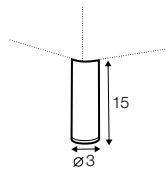

no. 111D  
metal chrome,  
painted black or grey  
and brushed steel\*

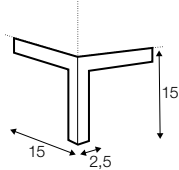

no. 124  
metal chrome,  
painted black or grey  
and brushed steel\*

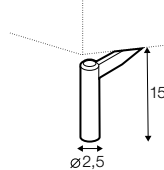

no. 145  
metal chrome,  
painted black or grey  
and brushed steel\*

### All legs can be fixed to both armrests:

---

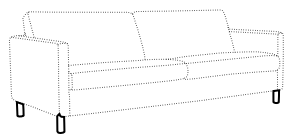

under armrest

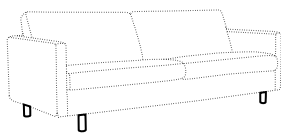

under frame

## profile

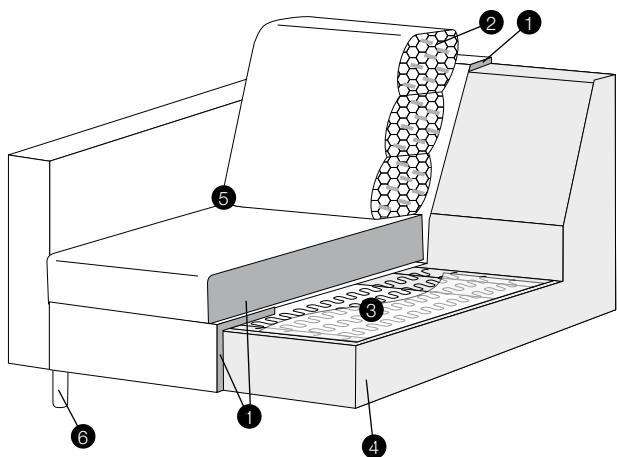

### standard

1. polyurethane foam/ high resilient polyurethane foam
2. foam flakes with silicone balls
3. springs
4. FSC® certified solid wood and wood based elements
5. fabric or leather
6. FSC® certified solid wood or metal legs

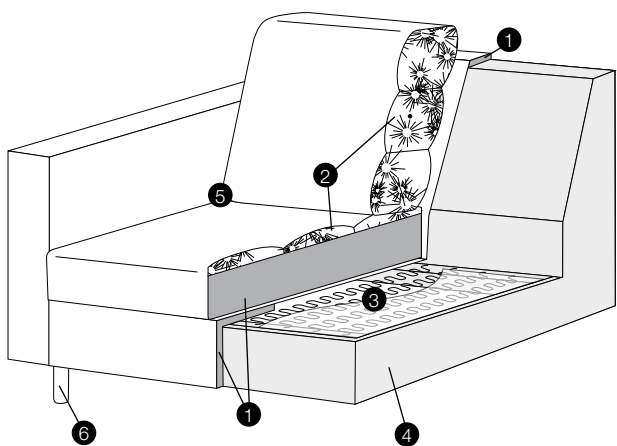

### lux

1. polyurethane foam/ high resilient polyurethane foam
2. cushion chamber with mix of feather and silicone balls
3. springs
4. FSC® certified solid wood and wood based elements
5. fabric or leather
6. FSC® certified solid wood or metal legs

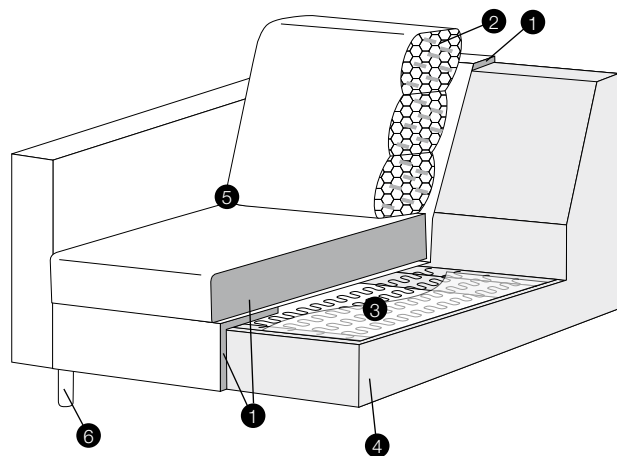

### classic

1. polyurethane foam/ high resilient polyurethane foam
2. foam flakes with silicone balls
3. springs
4. FSC® certified solid wood and wood based elements
5. fabric or leather
6. FSC® certified solid wood or metal legs

## profile

---

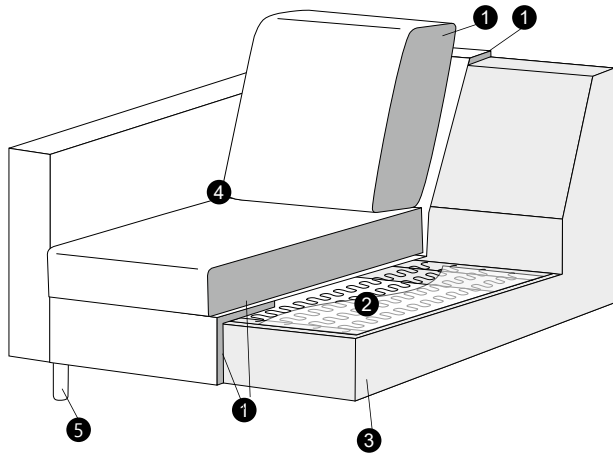

### plus

1. polyurethane foam/ high resilient polyurethane foam
2. springs
3. FSC® certified solid wood and wood based elements
4. fabric or leather
5. FSC® certified solid wood or metal legs